

, 20, . ,  
.(380 44) 456-9357  
E-mail: [okiliev@academy.gov.ua](mailto:okiliev@academy.gov.ua)  
<http://www.IPAS.org.ua>

, 20, . ,  
. \ (380 44) 456-1386  
E-mail: [vtertychka@yahoo.com](mailto:vtertychka@yahoo.com)  
<http://www.IPAS.org.ua>



- 
- 
- 
- 

,

,



- ... : , / .  
 , . – : “ .. .”, 2004. – 210 . (www.  
 IPAS.org.ua/library.htm)
- / . . . ,  
 .. . – : - , 2001. – 236 .
- : . ./ ; .  
 . . ; . . . . – : , 1999. – 175 .
- - . - :  
 , 1996. – 128 .
- : / . . . –  
 : , 2000. – 190 .
- / . . – : , 2000. –  
 243 .
- : / . . . – : , 2000. – 671
- : . – : , 2001. – 242 . , ,

- . . . . . / . . . . . – ∴  
 . . . . . , 2003. – 350 .
- . . . . . ; . . . . . – ∴ : . . . . . / . . . . . ,  
 . . . . . , 1998. – 654 .
- ∴ - “ . . . . . ”, 2003. – 346 . (www. IPAS.org.ua/library.htm)  
 / . . . . . –
- ∴ :  
 / . . . . . – ∴  
 “ . . . . . ”, 2006. – 388 . (www. IPAS.org.ua/library.htm)
- ∴ - “ . . . . . ”, 2004. – 871 . / . . . . . -
- - “ . . . . . ”, 2001. – 238 . / . . . . . - ∴
- . . . . . : . . . . . /  
 . . . . . – ∴ : . . . . . – 264 .
- ∴ : . . . . . / . . . . . – ∴ -  
 “ . . . . . ”, 2004. – 394 .
- . . . . . – ∴ - / ∴ ; . . . . .  
 . . . . . – ∴ - “ / ”, 2004. – 396 .

- . . . / . . . ; . . .  
 . . . - : , 2005. - 468 .
- . . . : / . . . ;  
 . . . - : , 2005. - 504 .
- : . . . /  
 . . . ; . . . , . . . - : - , 2000. - 232 .
- . . . 1 / . . . ; . . .  
 . . . - : - “ . . . ”, 2004. - 202 .
- : . . . / . . . ,  
 . . . ; . . . , . . . - : -  
 , 2001. - 480 .
- / . . . . . - : , 2004.
- / . . . . . - . , 2002. - 104 .

- 2002. – 232 . Internet. – “ . . . ”,
- IPAS.org.ua/library.htm) “ ”, 2003. – 510 . (www.
- / . . . ’ . –
- “ ”, 2004. – 127 .
- / . . . , 2003. – 151 .
- / . . . , 1999. – 422 .
- “ - ”, 2006. – 549 .
- “ ” . – : , 2002. – 80 .
- // . – 1999. – 9.
- – . 36-64.
- . – : - “ . . . ”, 2002. – 60 . (www.
- IPAS.org.ua/library.htm)

- - .: - " . . .", 2002. - 320 . ([www.IPAS.org.ua/library.htm](http://www.IPAS.org.ua/library.htm)) , . . . .
- . . . " . . .", 2002. - 750 . ([www.uapa-csar.org.ua/](http://www.uapa-csar.org.ua/)) . - .: -
- - : . . . . - : . - , 2002. - 60 . /
- " : : / . . . . . - .: " . . .", 2003. - 130 . ([www.IPAS.org.ua/library.htm](http://www.IPAS.org.ua/library.htm))
- New Approaches to Public Policy in Ukraine: Lessons Learned from New EU Member States. Executive Intern Program analytical reports and policy papers/ Eds. O.Kilievych, V.Tertychka. – Kyiv: “K.I.C.”, 2006. – 230p.
- Public Policy in Central and Eastern Europe: Theories, Methods, Practices / Ed. M.Potucek, L.T.LeLoup, G.Jenei, L.Varadi. – NISPAcee, 2003. – 340 p.Tertychka V. Implementation of Specialization “Public Policy Analysis” to the Ukrainian Training Programs for Public Servants: Opportunities and Barriers// [http://www.nispa.sk/\\_portal/files/conferences/2006/papers/200604101828260](http://www.nispa.sk/_portal/files/conferences/2006/papers/200604101828260)



- [www.rada.gov.ua](http://www.rada.gov.ua) – . -
- [www.kmu.gov.ua](http://www.kmu.gov.ua) – . -
- [www.center.gov.ua](http://www.center.gov.ua) – ( “ ”)
- [www.civic.kmu.gov.ua/civic/control/uk/index](http://www.civic.kmu.gov.ua/civic/control/uk/index) – “ ”
- [www.icps.kiev.ua](http://www.icps.kiev.ua) – ( )
- [www.IPAS.org.ua](http://www.IPAS.org.ua) –
- [www.nispa.sk](http://www.nispa.sk) –



**1.**

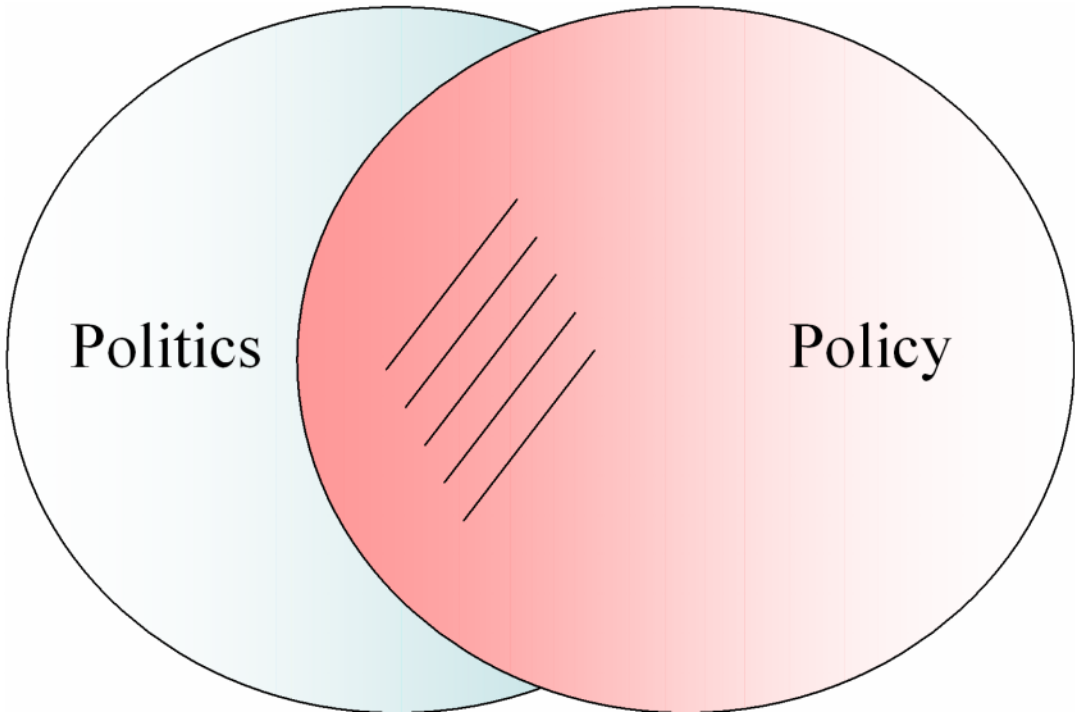

“

(  
”

)

# Суспільні науки

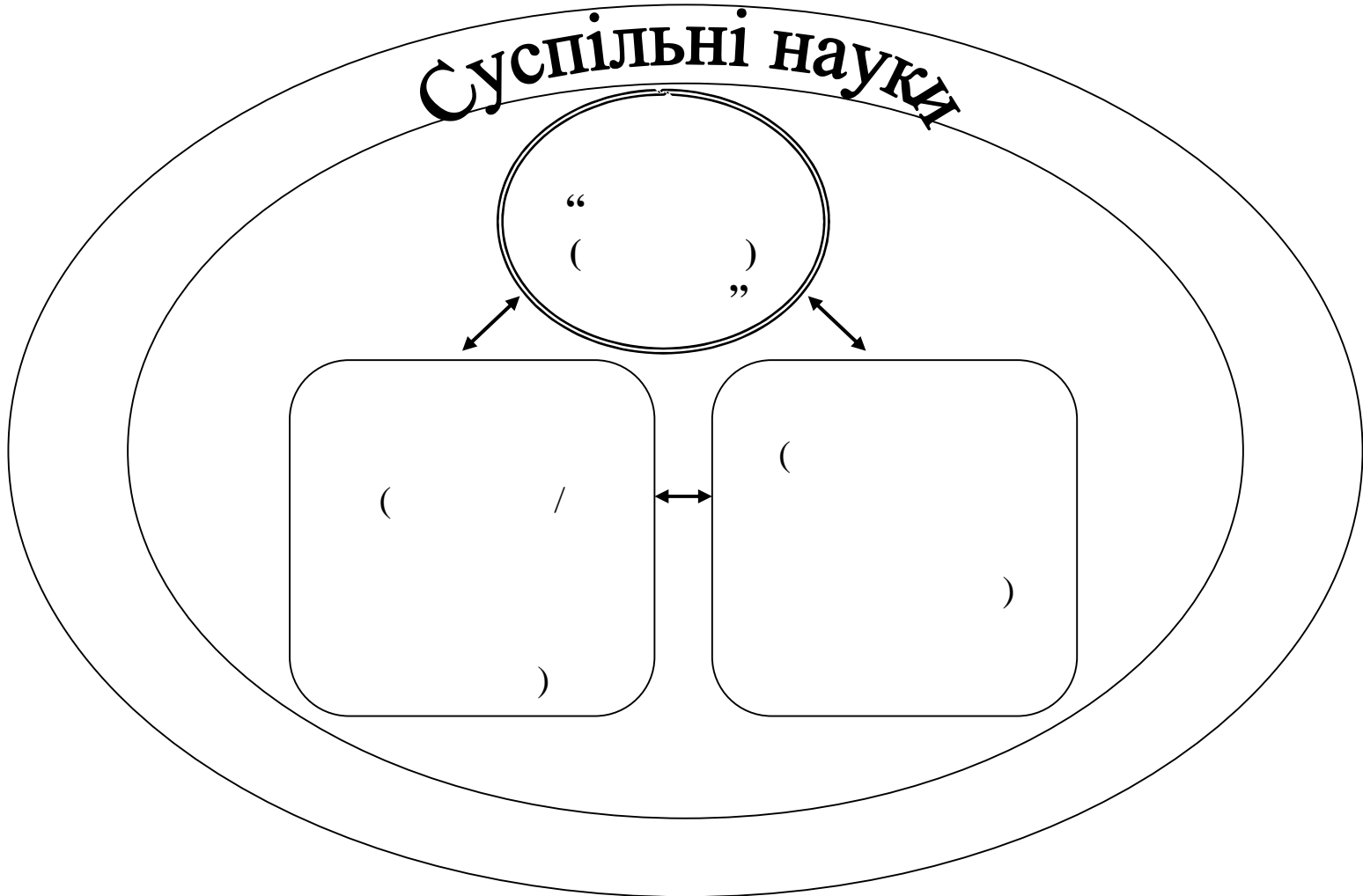

( - , ) ,

,

**2.**

■

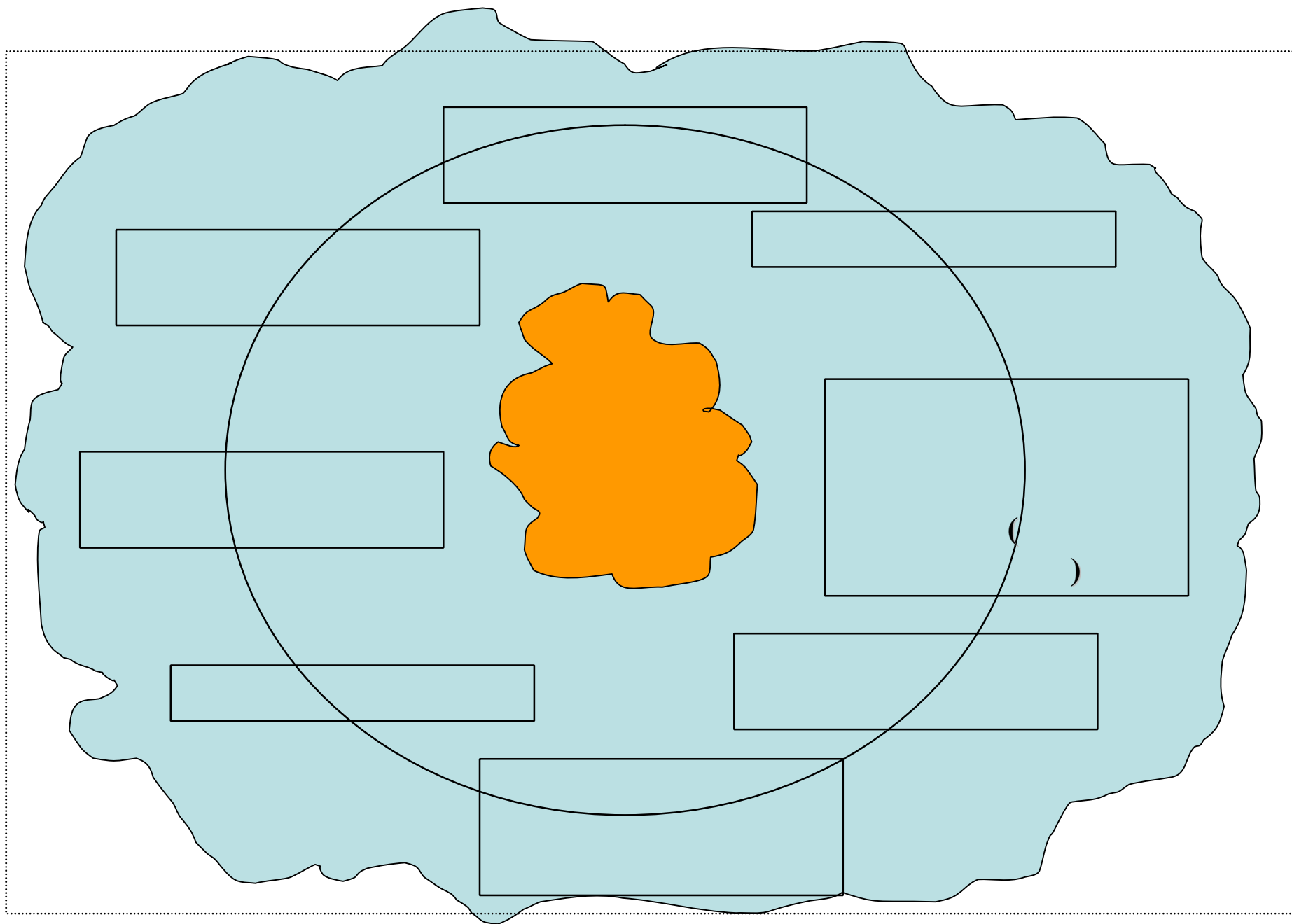

■  
■

,

,

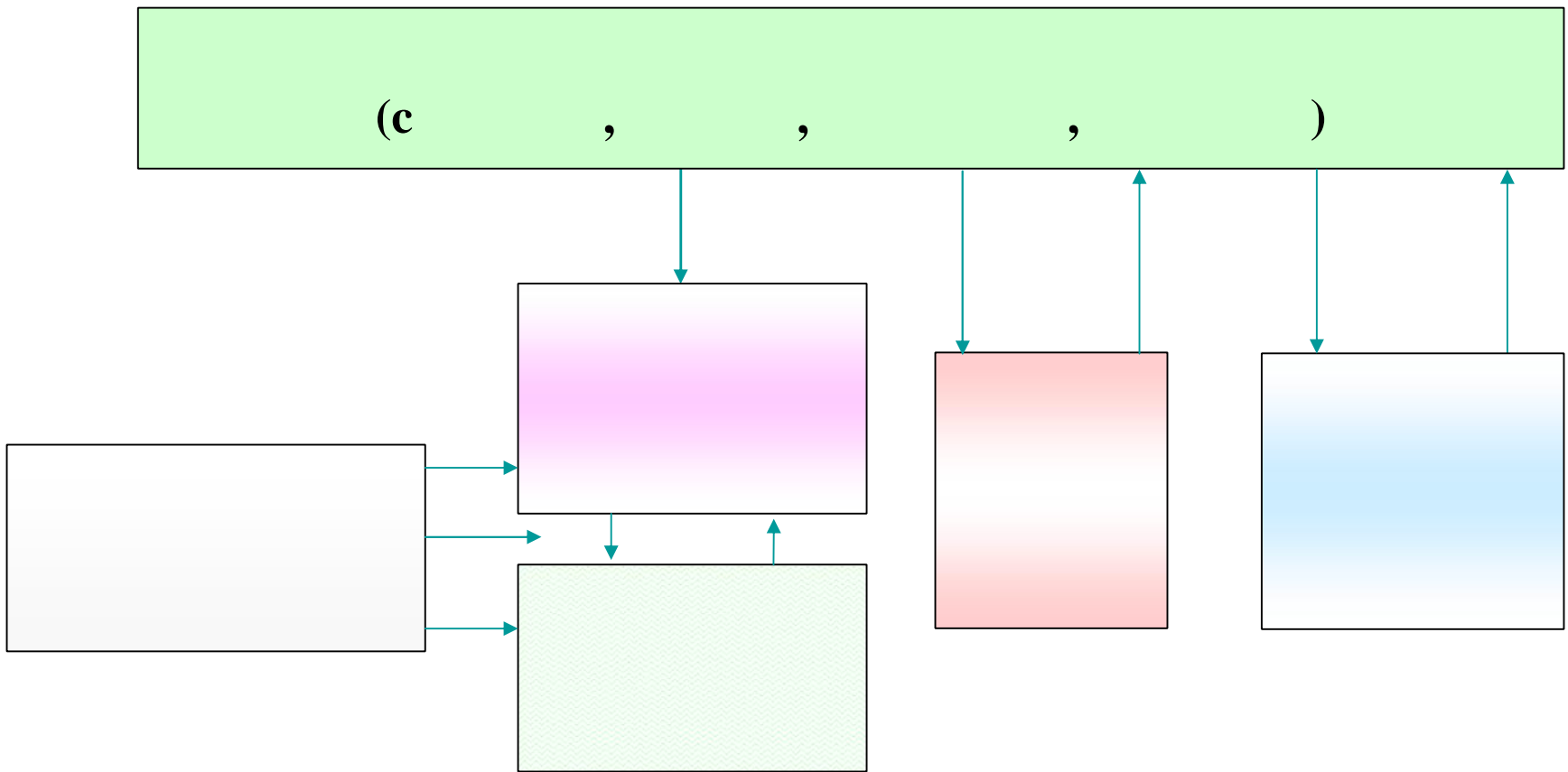



**3.**

**:**

**;**

...

■



—

,

\_\_\_\_\_.

—

( ’ )

-

/

,

—

,

,

“

”

.

:

?

?

“

”

( ) – **SMART**

**Specific** –

**Measurable** –

**Available** –

**Realistic** –

**Time-bound** –



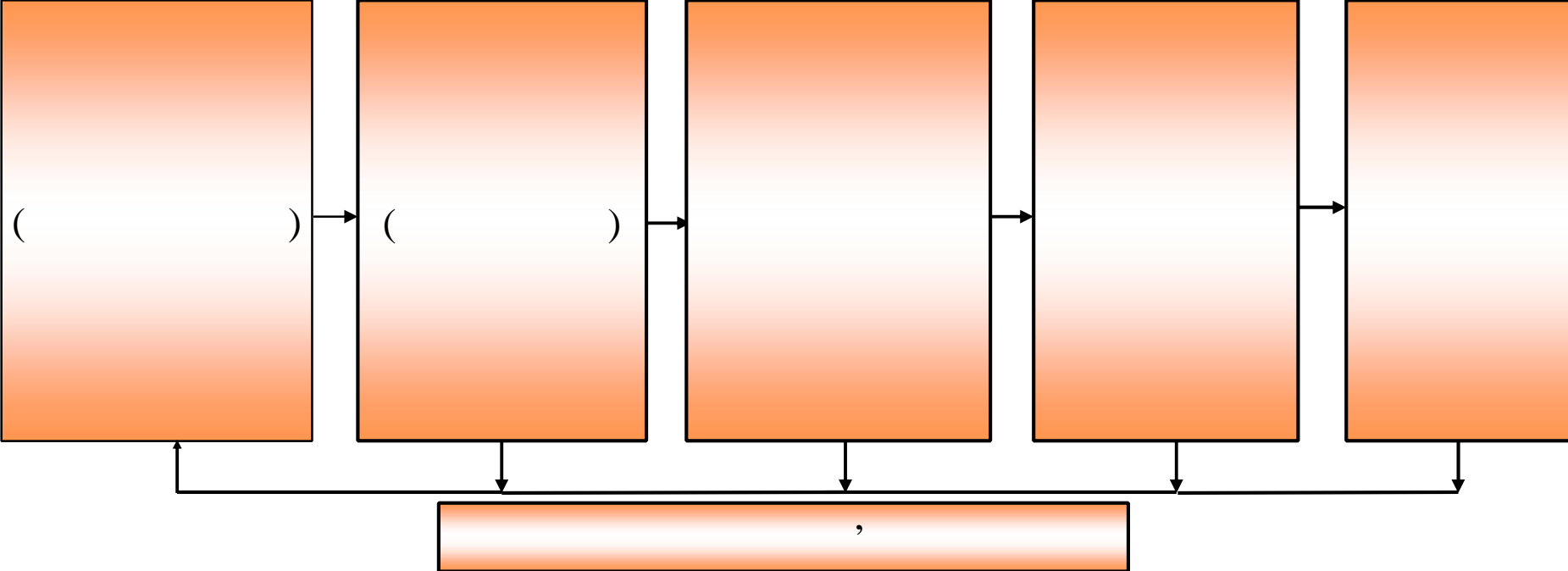

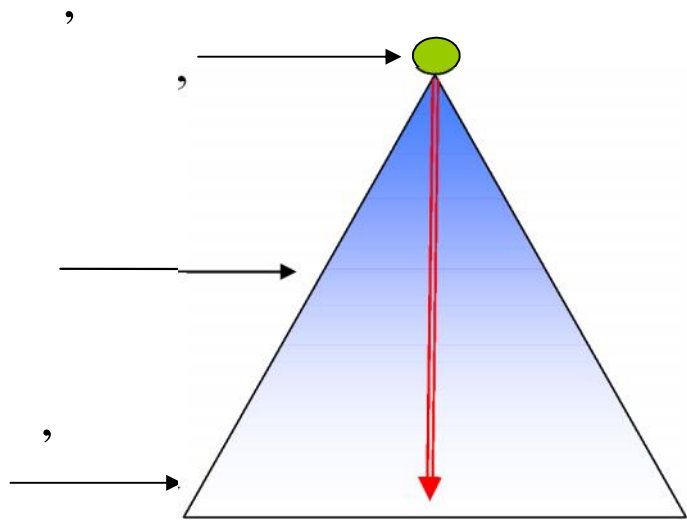

1.

-

,

,

,

.

2.

-

,

,

.

3.

-

,

,

.

4.

-

,

;

5.

-

,

,

,

.

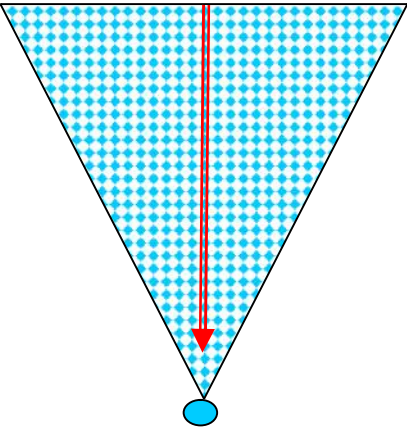

,

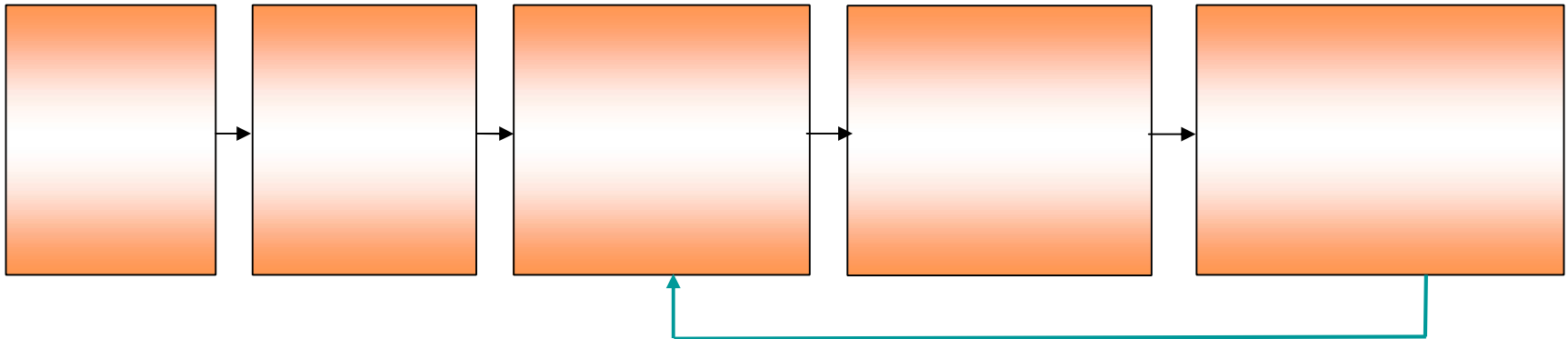

•

•

•

•

,

•

(

)

,

•

,

"

"

,

•

(

)

,

.

,

,

●

,

:

.

,

;

.

,

,

,

.

;

.

.



,

•

,



• ? •

: ,

, ,

• ? •

? :

• ? •

: ?

• ?



\_\_\_\_\_



\_\_\_\_\_ ,

—

⋮



—

,



—



—

,

•

•

•

•

4.

■

■

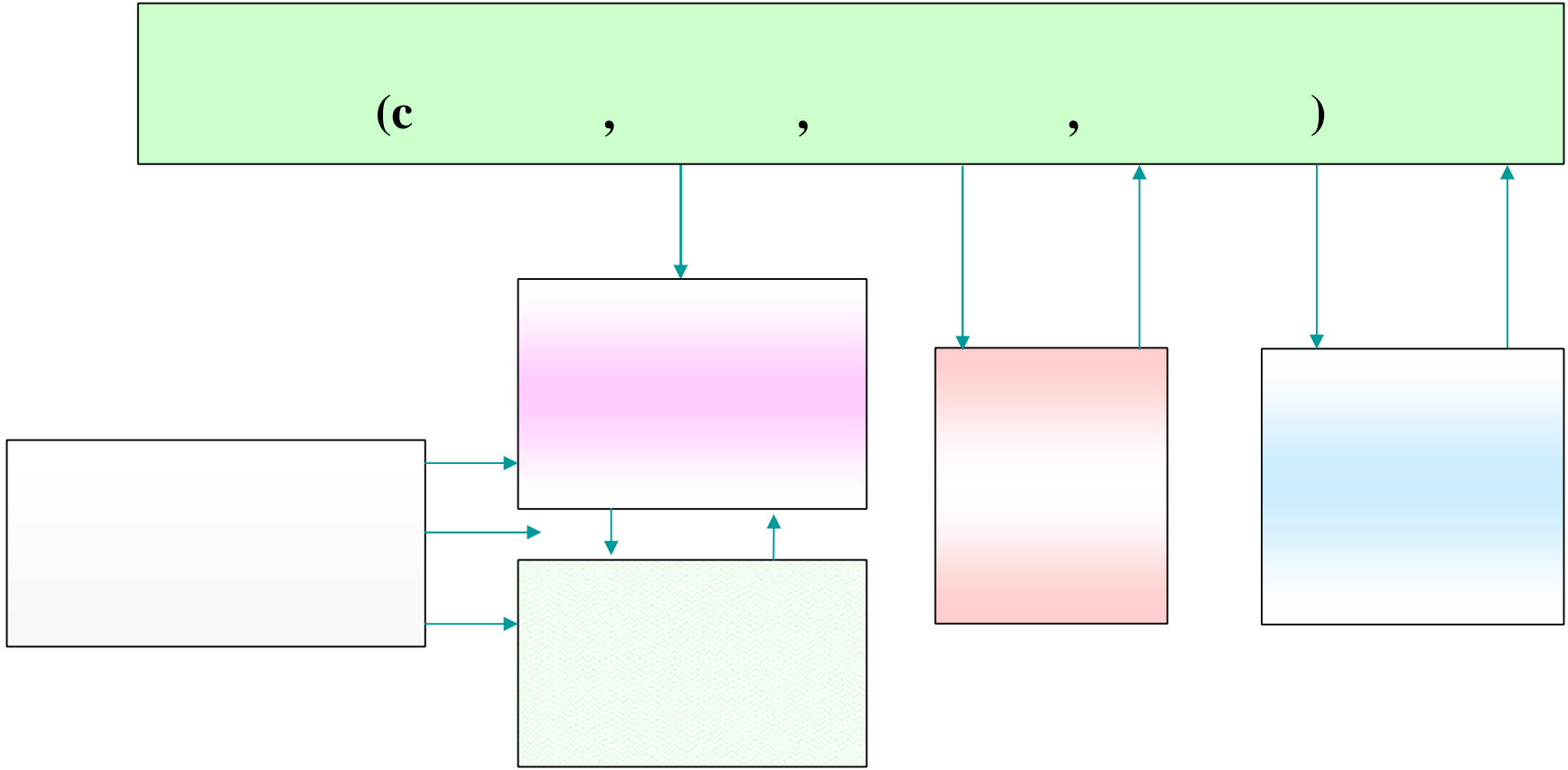

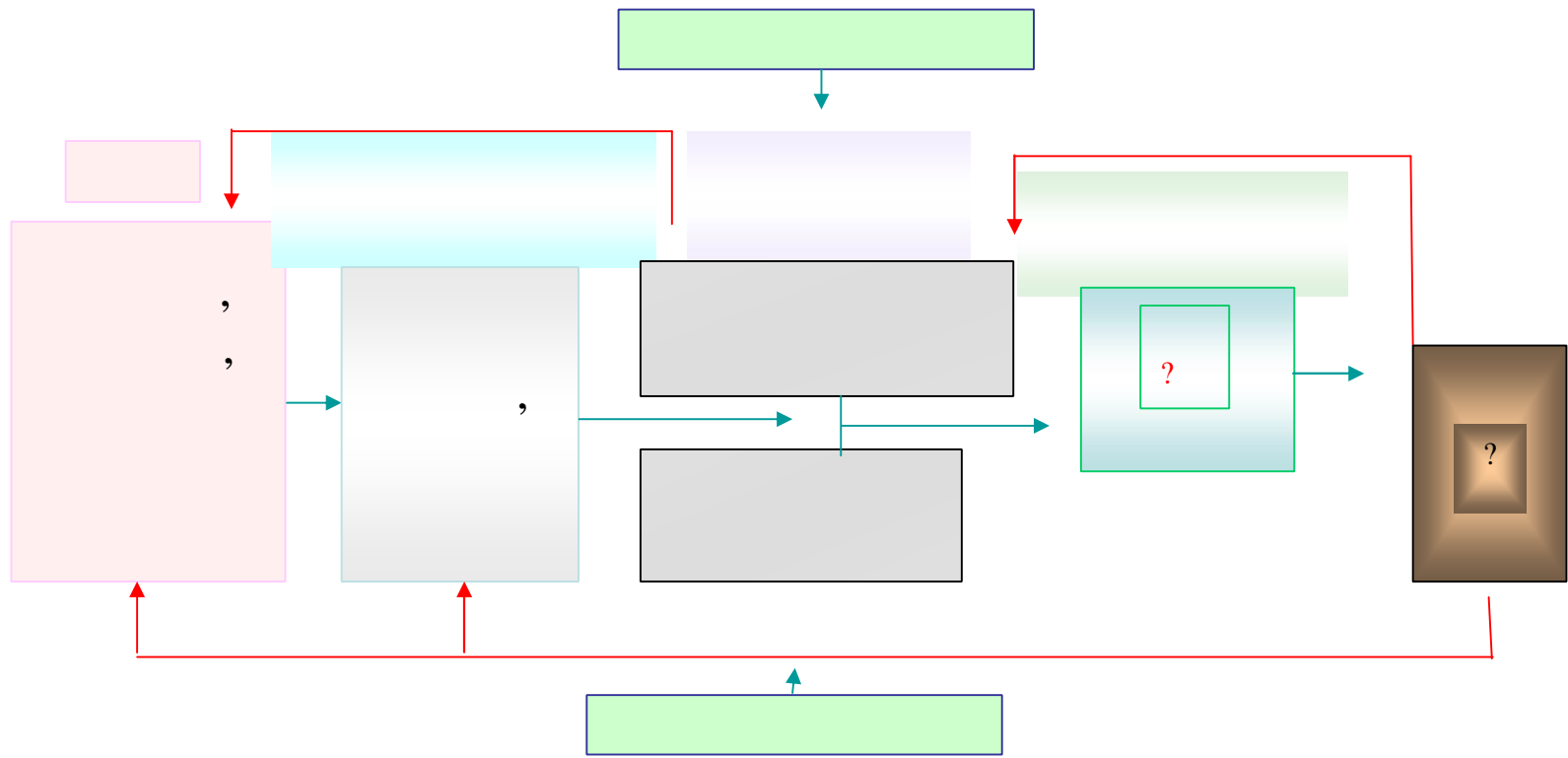

(1):

(social environment):

,

,

,

,

;

(physical environment):

:

,

,

,

;

-

:

,

,

,

,

,

;



(2):

• ( n m environment):

,

,

,

,

,

;

• ( litical environment):

,

,

,

,

,

,

,

,

,

,

.

●

“

”

—

,

•

“

”

—

,

(1):

— , « » ,  
,  
.  
— ,  
,  
.  
—

.

(2):

— ), ( ' , . ; , . — , . — , . , — , .

( ( ) ) :

•

,

,

(

,

/

);

•

:

,

/

.

- 1276/2005 . 15 2005
- 712 . 8.07.2009
- . 3.11.2010 . N 996.
- , ,
- . 11 2004 . 150
- . 5 2008 . 976
- ,
- 2010 . N 1912- 29
- . 21 2007 . N 1035-

**5.**

**:**

(1) \_\_\_\_\_ , :

( ) ( ' )  
( ) ( );

(2) : ( )

( ) \_\_\_\_\_ ,

( ) \_\_\_\_\_ ,

( ) \_\_\_\_\_ ;

(3) ( ) . ,

.



•

(“ ?”) -

;

,

•

(“ ?”) -

,

.

•

•

,

(

),

-

-

.

•

•

,

,

•

( )

• — ,

.

• — .

• ( ) — ( , , )

• ( ) — , .

•

•

•

•

”

•

•

”

”

”)

(

,

	,	
:		
:	1) 2) 3)	
:	( ; ) )	( )

- **1)**

(

):

- 1.1)

,

- 1.2)

,

- 1.3)

,

- 1.4)

,

- 1.5)

;

- **2)**

;

- **3)**

;

- **4)**

.

;

•

•

•

•

•

•

•

(

,

).

•

-

,

•



**6.**

■

■

( , )	( , )	,	-
( , )	( , )	( , )	- ,
( , )	( , )	( , )	,
( , )	( : , )		,
			,
			( )
			( , )
			( )

( )

- ;
- , ;
- ;
- ;
- ;
- ;
- ;

436, . 12

16.01.2003

•

,

•

,  
,

•

,

•

,

,

,

,

,

,

,

• ,

• ,

• - ,

-

• ,

,

,

• - ,

• — -

—

—

,

,

,

,

•

•

•

•

•



		. 1	. 2	. 3
1.	<b>(Effectiveness)</b>			
2.	<b>(Efficiency)</b>			
3.	<b>(Equity )</b>			
4.				
5.				

•

:

,

—

,

,

,

.

.

.

• ,

( , , )

.(

,

).

:

,

,

(

),

( .

)

-

.

•

,

)

(

-

,

.(

,

,

,

).)

-

,

-

.

•

,

.

(

,

).

,

,

.

.

•

,

•

,

,

⋮

,

,

,

•

•

•

,

•

●

,

-

,

,

.

-

-

.

,

.

●

,

.

,

.

-

,

.



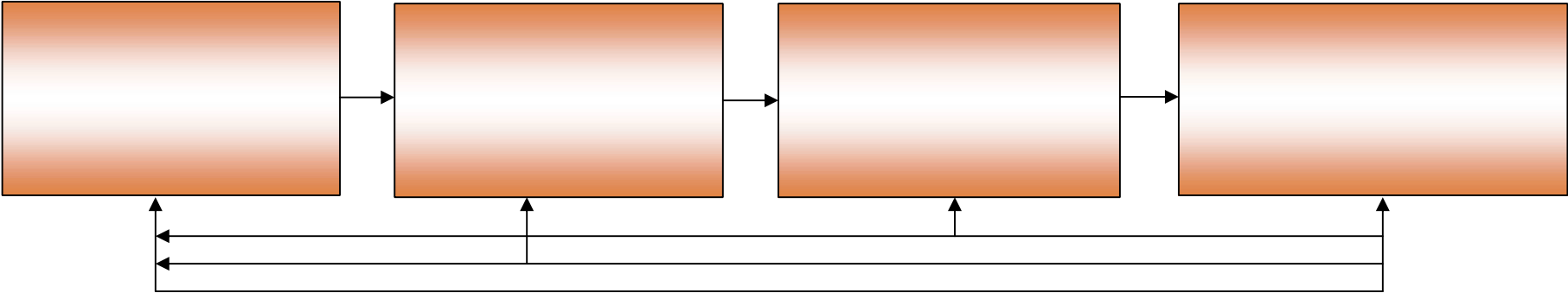

•

•

•

•  
;

•  
;

•  
•

•  
•

- “ ” (“Old”)
- “ ” (“New”)

“

”

:

.

,

,

.

,

.

“

”

⋮

.

,

.

,

,

.

•

(

•

•

•

)

-

⋮

•

**7.**

—

/

( . ) ’

,

,

,

,

,

,

,

,

.

.

(

)

,

,

,

/



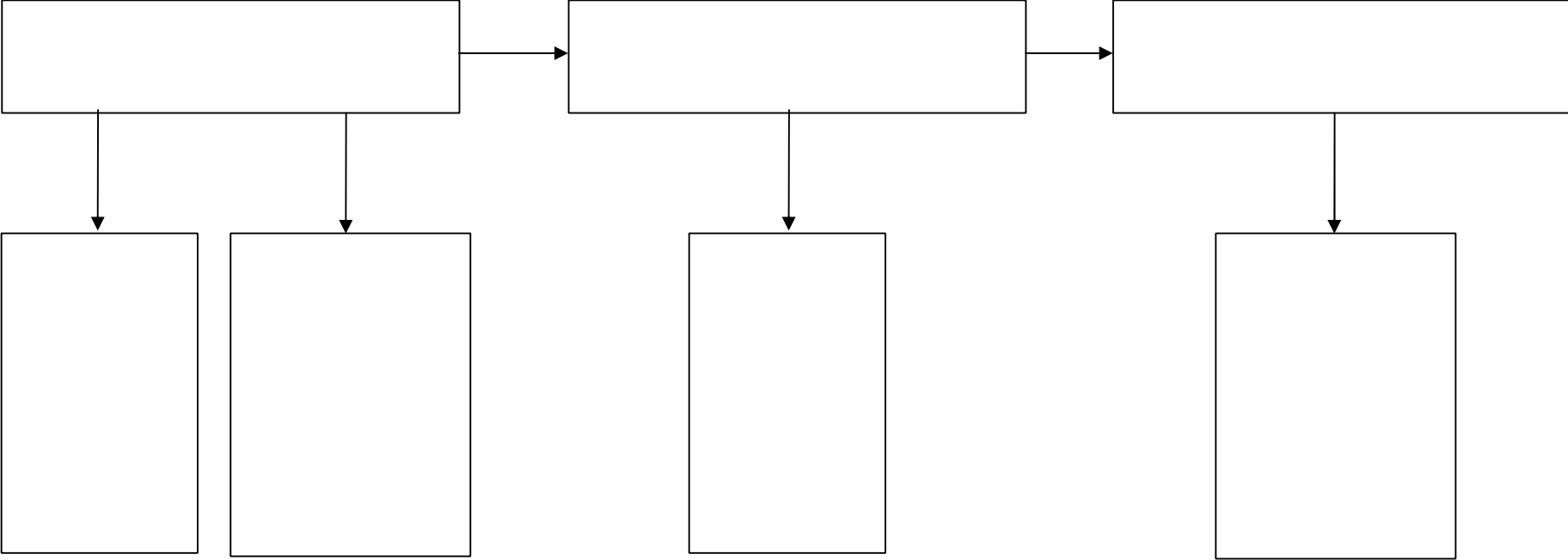

-

,

,

,

(

,

);

-

,

;

-

,

(

,

,

);

-

:

.

•

—

,

,

•  
•

•

—

,

"

,

,

,

,

"

.



•  
;



•  
•

/

•

,

,

•

,

,

,

•

•

•

,

,

!

-

•

•

•

,

,

,

,

,

,

,

,

•

⋮  
/

•

•

-

•

•

•

•

•

,

,

,

,

•

—

-

•

⋮

/

•

.

,

,

,

,

—

.

,

•

.

"

"

.

,

:

:

.

—

—

—



•  
•

•

•

•

•

, “ ” ,

.

,

.

,

,

.

.

—

.

,

,

,

,

,

.

?,

:

?,

?

# (Performance Auditing)

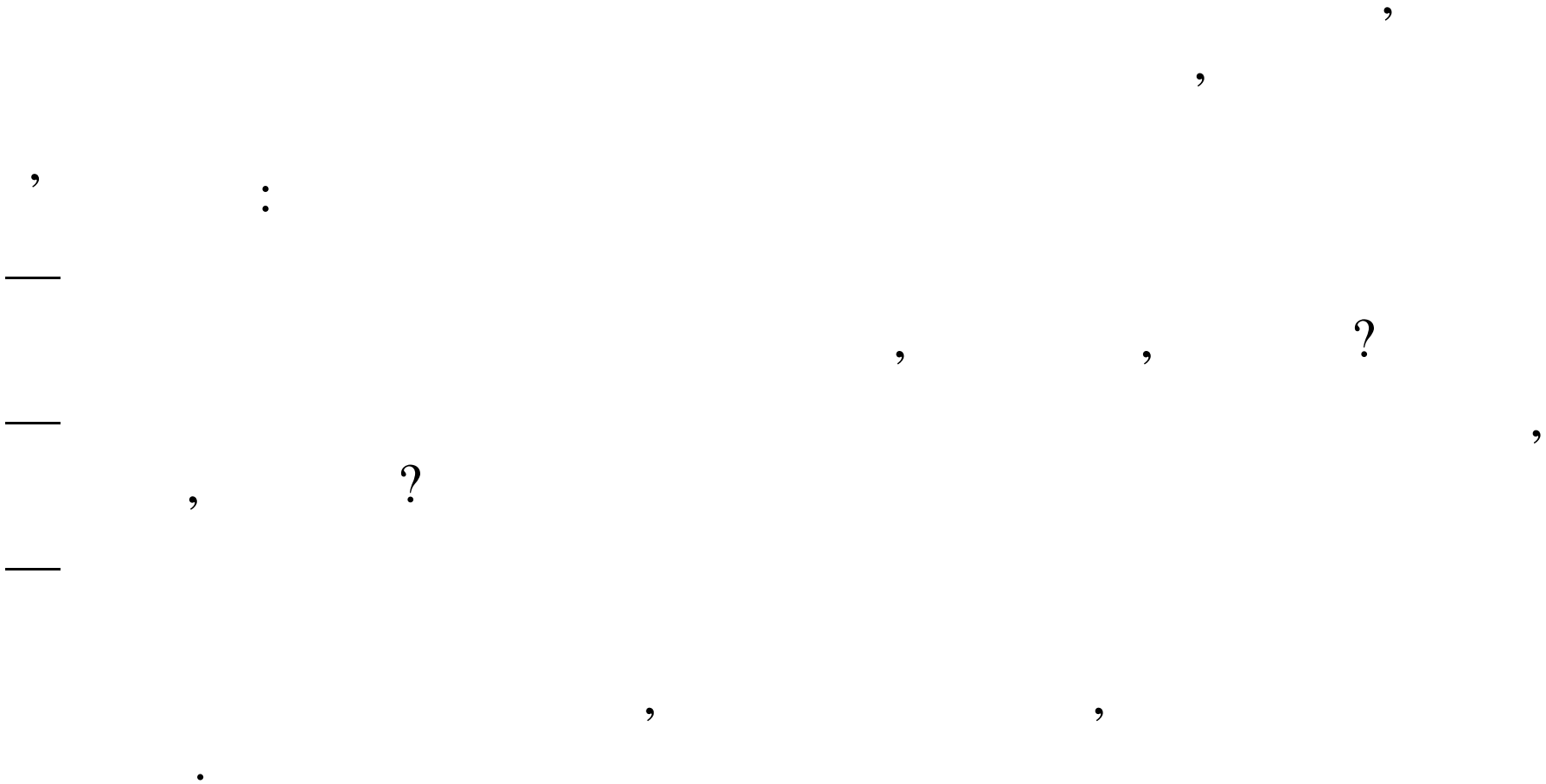

**8.**

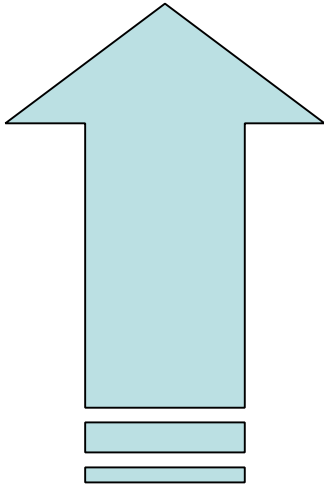

( )

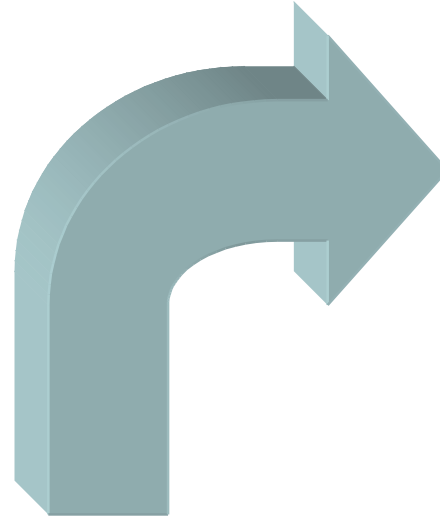

/

“ ” / Green Papers

“ ” / White Papers

⋮

