



“ ,

”

29-30 2010 .

• ,

“ ,

”

, 20, . ,
.(380 44) 456-9357
E-mail: lesya@rocketmail.com
<http://www.IPAS.org.ua>

, 20, . ,
.(380 44) 456-9357
E-mail: okiliev@academy.kiev.ua
<http://www.IPAS.org.ua>

, 20, . ,
.\ (380 44) 456-1386
E-mail: vtertychka@yahoo.com
<http://www.IPAS.org.ua>



-
-
-
-

,

,



●

...

■ ■ ■

■ ■ ■

■ ■ ■

■ ■ ■

■ ■ ■

■ ■ ■





- ... : ,
 , . – : “ .. .”, 2004. – 210 . (/www.
 IPAS.org.ua/library.htm)
- / . . . ,
 .. . – : - , 2001. – 236 .
- : . ./ ; .
 . . . ; – : , 1999. – 175 .
- - . - :
 , 1996. – 128 .
- : / . . . -
 : , 2000. – 190 .
- / . . – : , 2000. –
 243 .
- : / .
 . . . ; – : , 2000. – 671

- / – ∴
 , 2003. – 350 .
- ; – ∴ : / ,
 , 1998. – 654 .
- ∴ - “ ”, 2003. – 346 . (www. IPAS.org.ua/library.htm) / –
- ∴ :
 “ ”, 2006. – 388 . (www. IPAS.org.ua/library.htm) / – ∴
- ∴ - “ ”, 2004. – 871 . / –
- - “ ”, 2001. – 238 . / , – ∴
- : /
 – ∴ : – 264 .
- ∴ : / ; – ∴ -
- – ∴ - “ / ;
 – ∴ - “ / ”, 2004. – 396 .

- . . . / . . . ; . . .
 . . . - : , 2005. - 468 .
- . . . : / . . . ;
 . . . - : , 2005. - 504 .
- : . . . /
 . . . ; . . . , . . . - : - , 2000. - 232 .
- . . . 1 / . . . ; . . .
 . . . - : - “ . . . ”, 2004. - 202 .
- : . . . / . . . ,
 . . . ; . . . , . . . - : -
 , 2001. - 480 .
- / - : , 2004.
- / - . , 2002. - 104 .

- “...”, 2002. – 232 . Internet. . – .: .
- “...”, 2003. – 510 . (www.
IPAS.org.ua/library.htm)
- “...”, 2004. – 127 . / . .
- “...”, 2003. –
151 . / . . . – .: .
- “...”, 1999. – 422 .
- “...”, 2006. – 549 . / .
- “...”, 2002. – 80 . :
– .: . –
- // . – 1999. –
9. – . 36-64.
- “...”, 2002. – 60 . (www.
IPAS.org.ua/library.htm)

- - .: - " . . .", 2002. - 320 . (www.IPAS.org.ua/library.htm) ,
- . . . " . . .", 2002. - 750 . (www.uapa-csar.org.ua/) . - .: -
- - : - : . - , 2002. - 60 . /
- " : : / - .: " . . .", 2003. - 130 . (www.IPAS.org.ua/library.htm)
- New Approaches to Public Policy in Ukraine: Lessons Learned from New EU Member States. Executive Intern Program analytical reports and policy papers/ Eds. O.Kilievych, V.Tertychka. – Kyiv: “K.I.C.”, 2006. – 230p.
- Public Policy in Central and Eastern Europe: Theories, Methods, Practices / Ed. M.Potucek, L.T.LeLoup, G.Jenei, L.Varadi. – NISPAcee, 2003. – 340 p.Tertychka V. Implementation of Specialization “Public Policy Analysis” to the Ukrainian Training Programs for Public Servants: Opportunities and Barriers// http://www.nispa.sk/_portal/files/conferences/2006/papers/200604101828260



- www.kmu.gov.ua —
- www.rada.gov.ua —
- www.intellect.org.ua —
- www.icps.kiev.ua —
- www.uapa-csar.org.ua —
- www.civic.kmu.gov.ua —
- www.IPAS.org.ua —

, (,) .

•

•

()

—

(- ,),

,

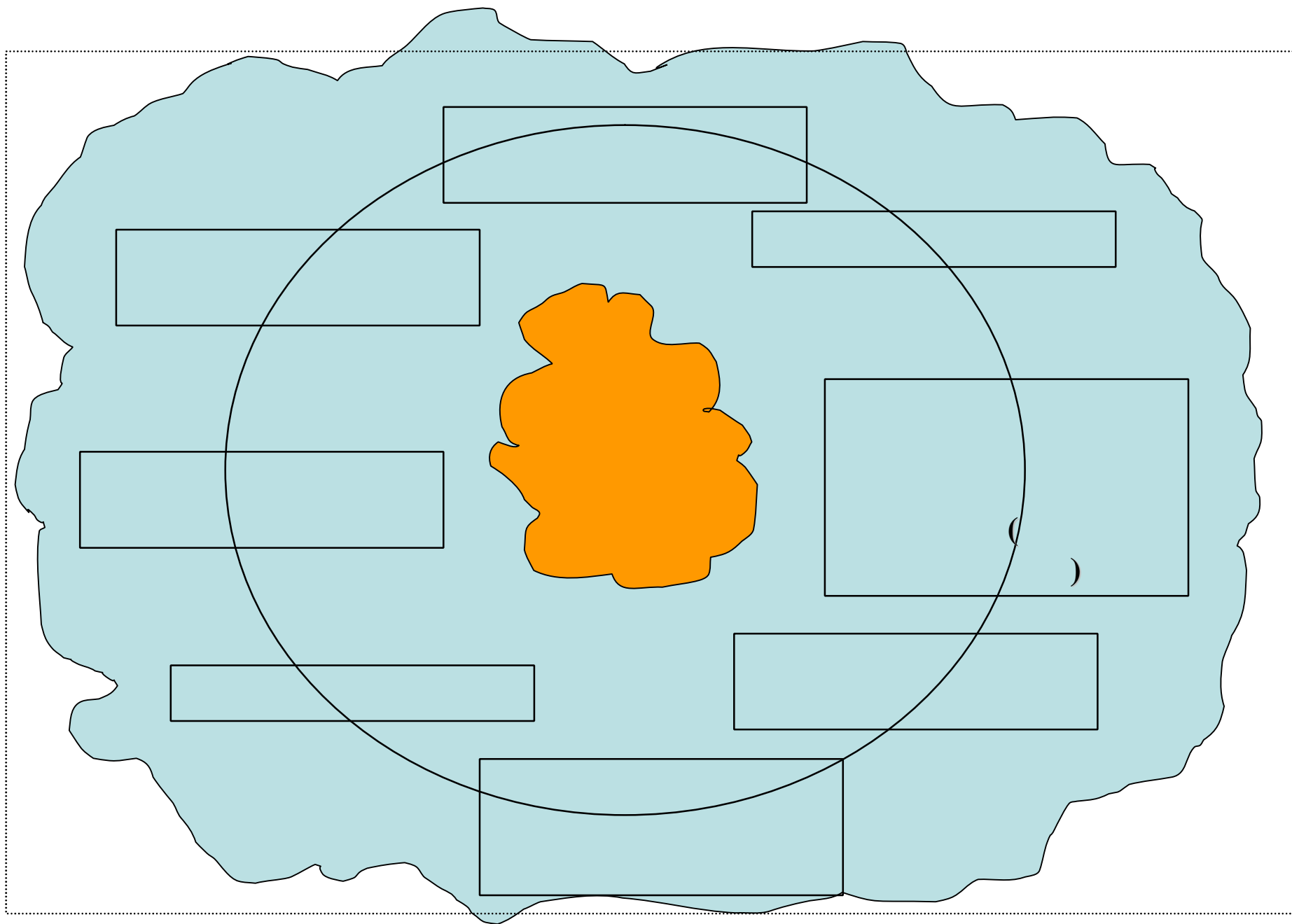

()

- (' ,
- , ,
. ,
- ;
- ();
- ;
-

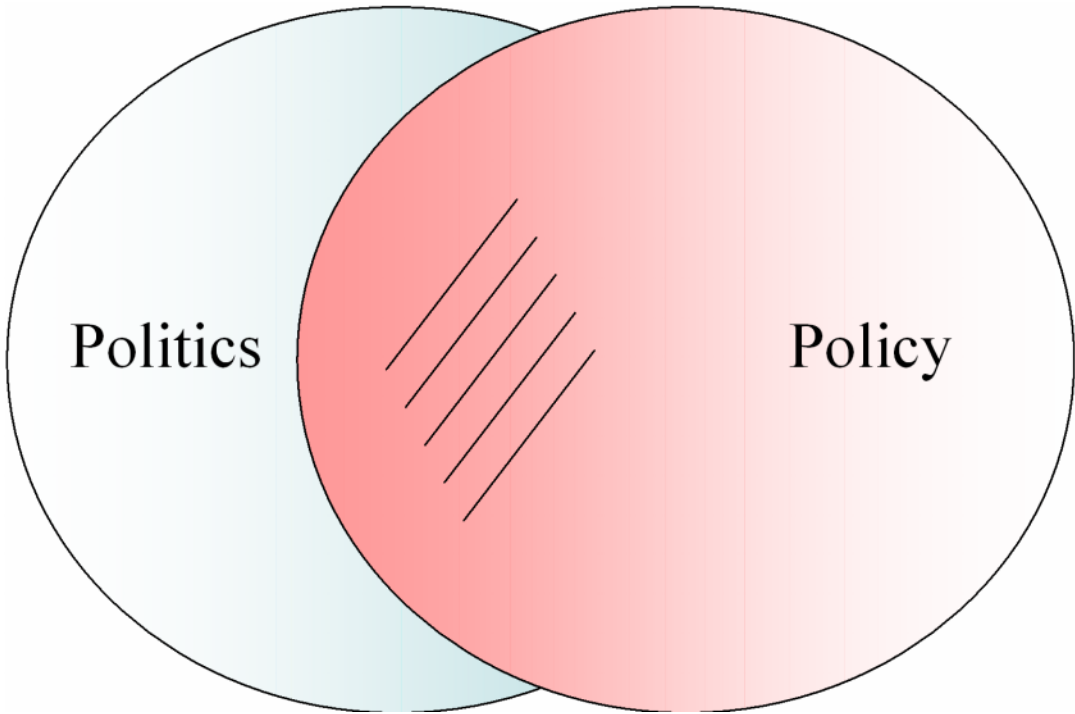



()

—

,

() - ' ,
() - /
, -

•

•

•

.

.

;

.

;

•

•

Суспільні науки

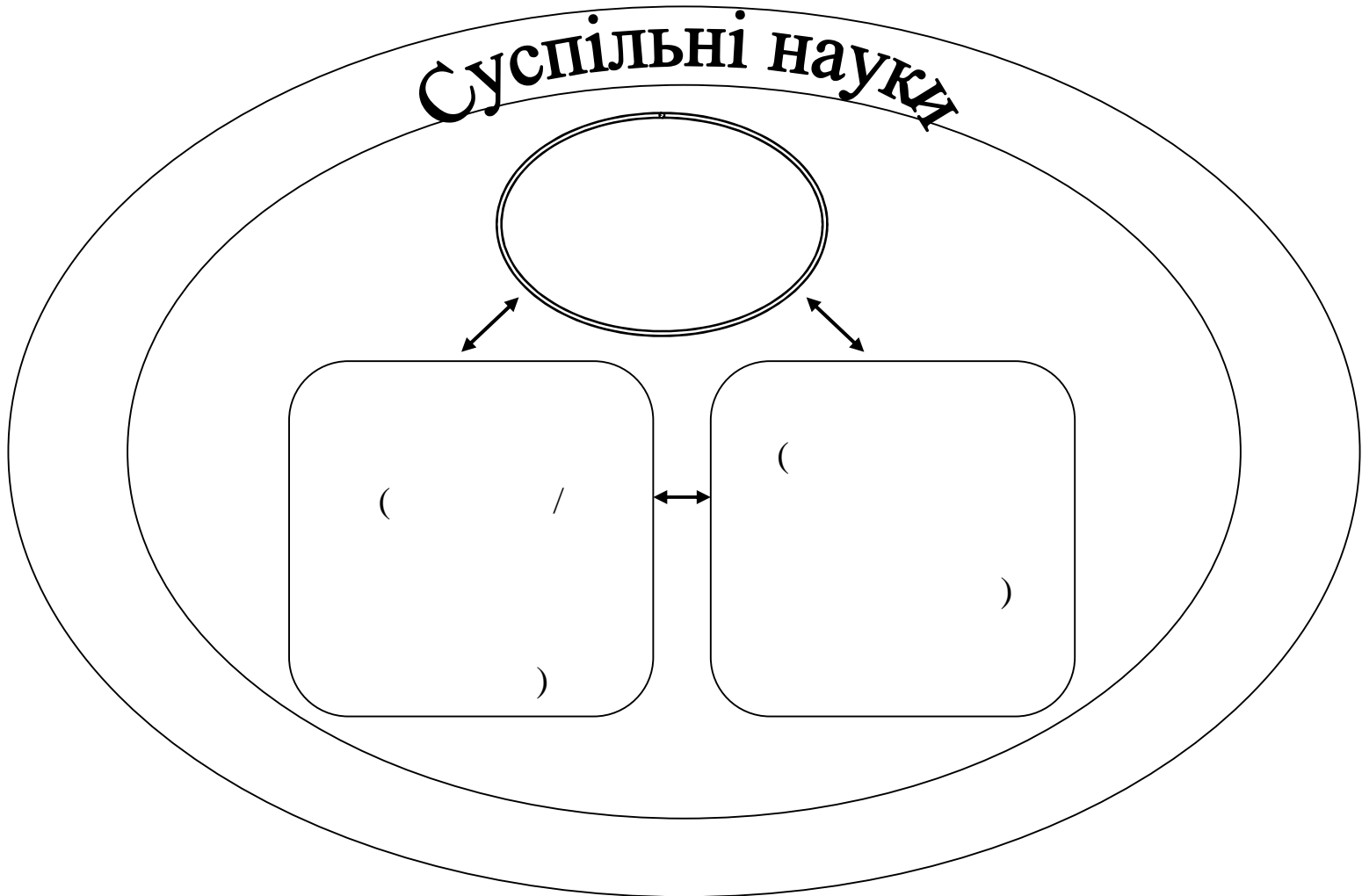

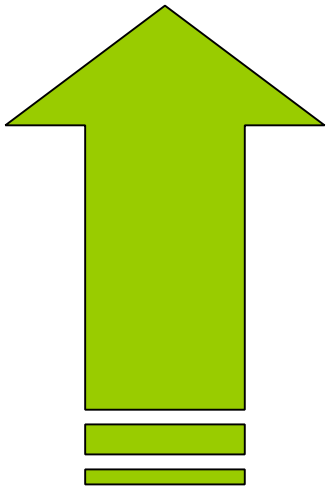

()



/

“ ” / Green Papers

“ ” / White Papers

•

,

•

,

•

—

,

•

—

,

,

—

•

,

•

/

—

•

—

,

(
)

•

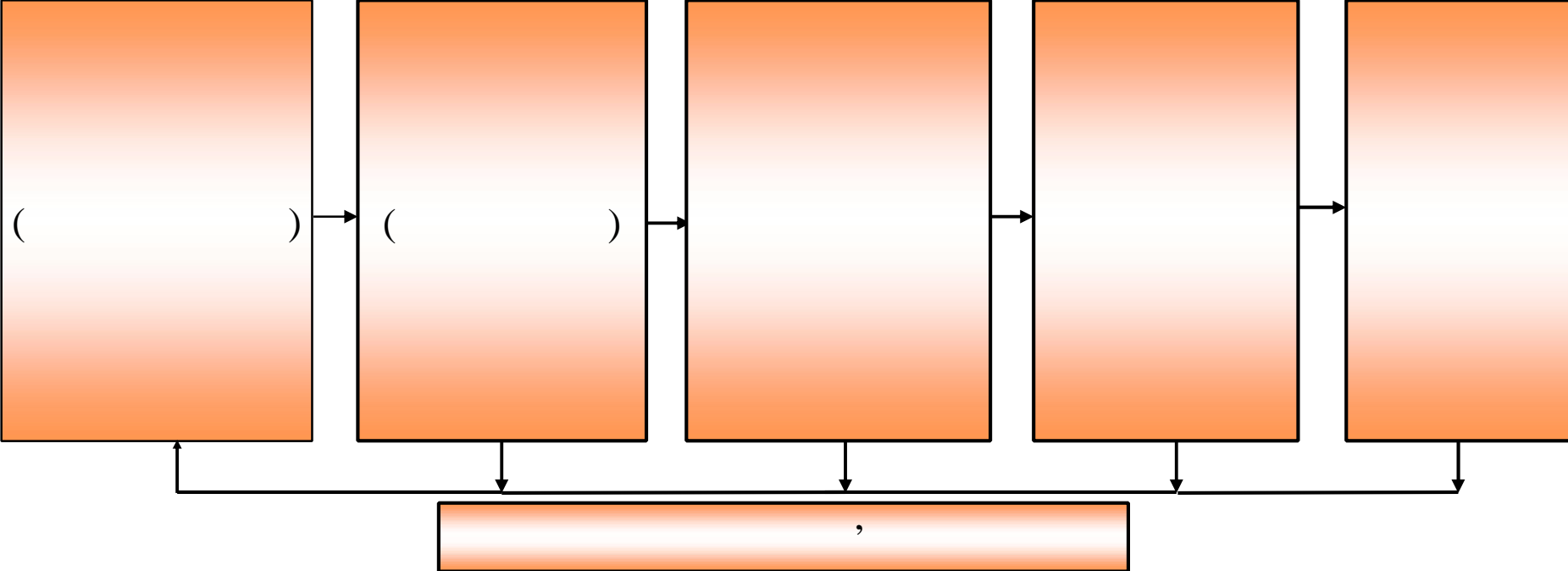

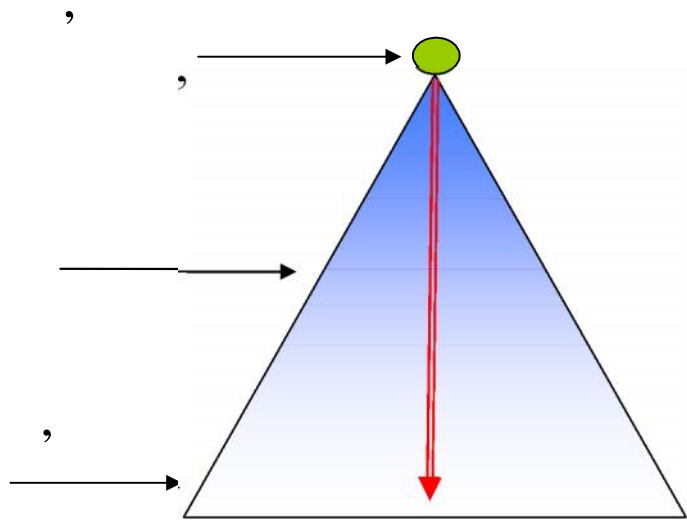

1.

-

,

,

,

.

2.

-

,

,

.

3.

-

,

,

.

4.

-

,

;

5.

-

,

,

,

.

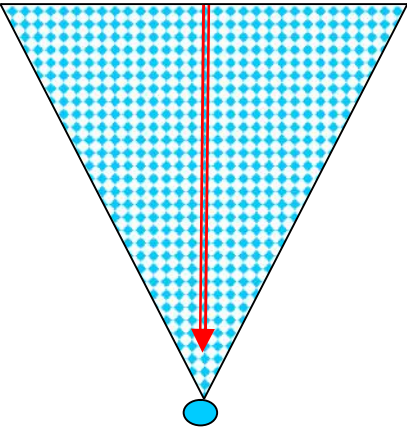

,

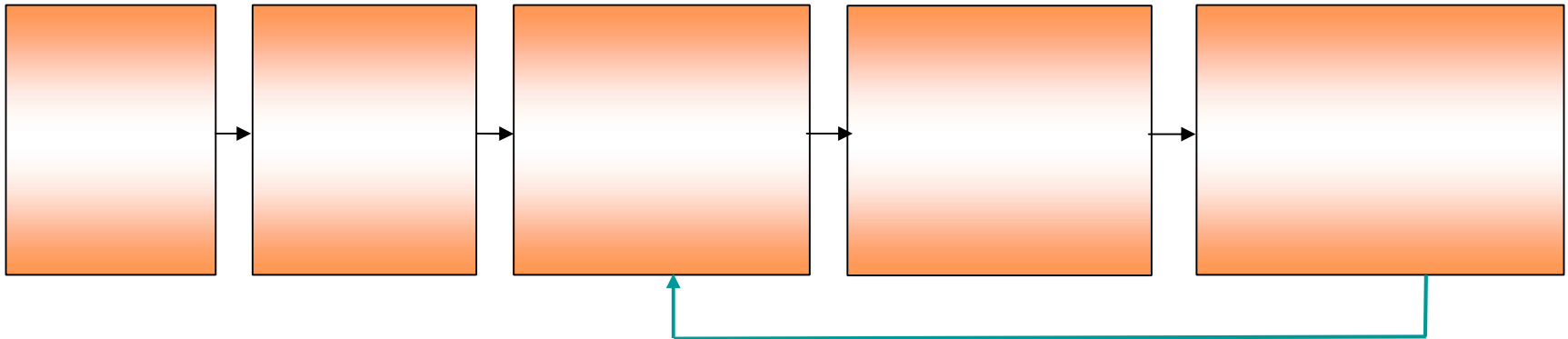

•

•

•

•

,

•

(

)

,

•

,

"

"

,

•

(

)

,

.

,

,

●

,

:

.

,

;

.

,

,

,

;

.

.

,

•

,

—

,

,

-
-

?

politics
policy

“

”

.

:

“

”

?

?

– SMART

Specific –

Measurable –

Available –

Realistic –

Time-bound –

,

,

:

(,)	(,)	,	-
(,)	(,)	(,)	- ,
(,)	(,)	(,)	, ,
(,)	(,)	(,)	(,)
(,)	(: ,)		(,)
	(,)		(,)
			(,)
			(,)

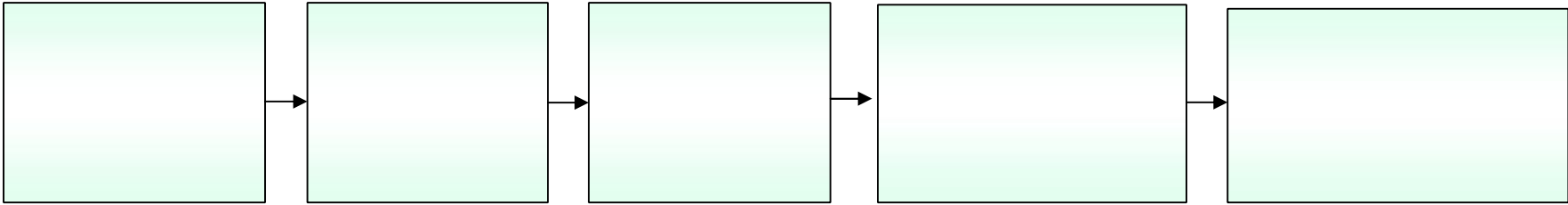

()

•

•
;

•

•
;

•

•
;

•

•
;

•

•

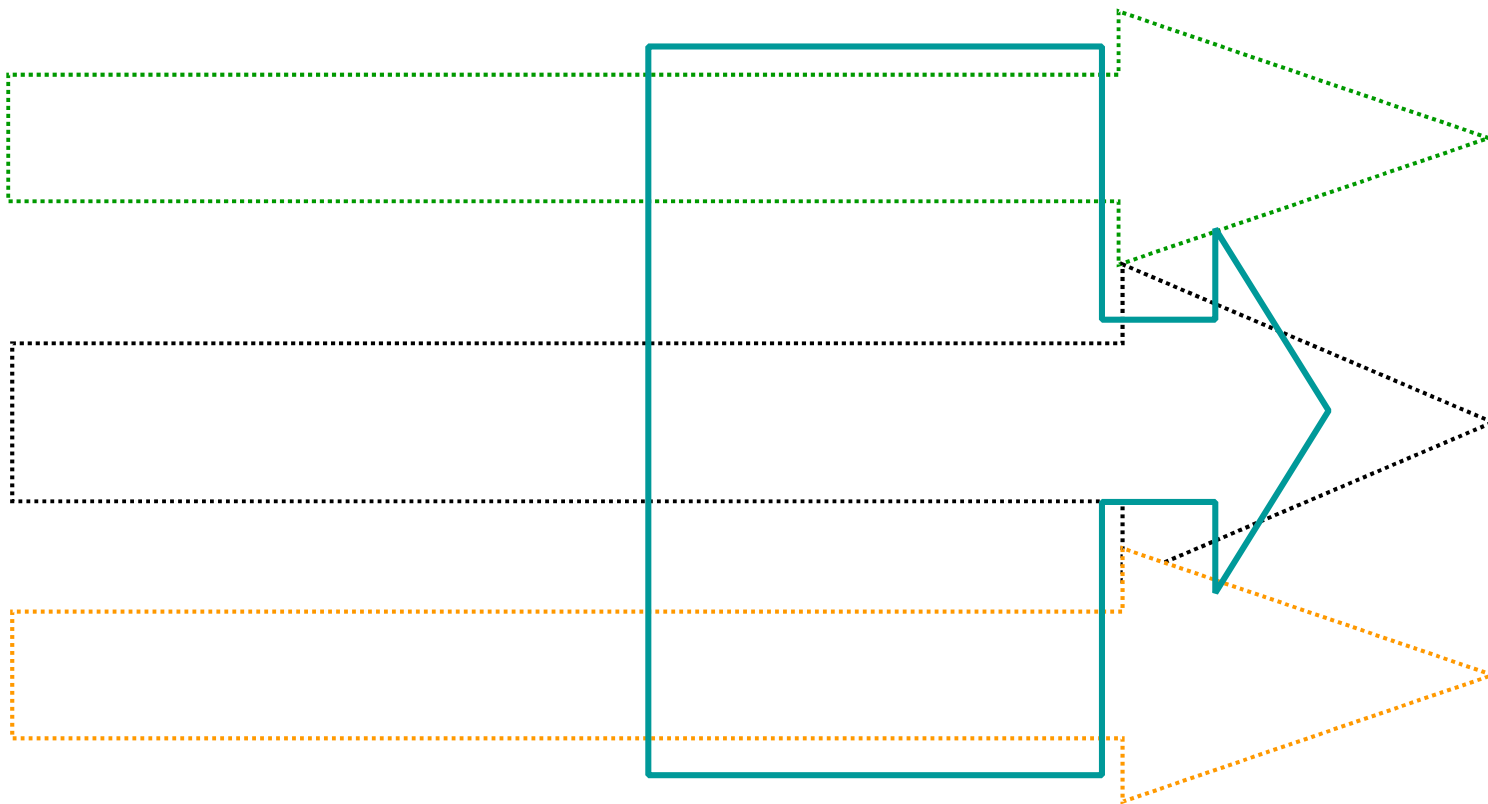

(

)

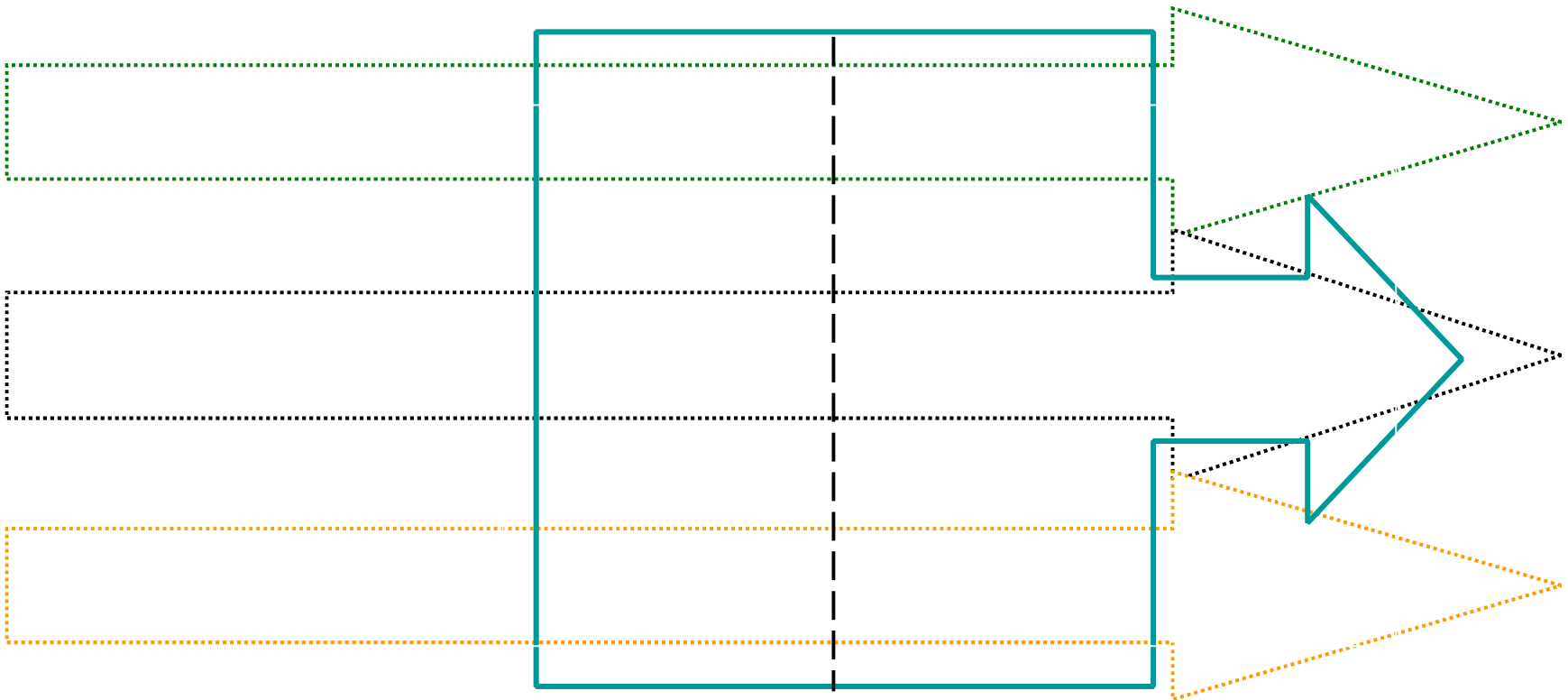

1.

?

2.

()?

•

•

,

,

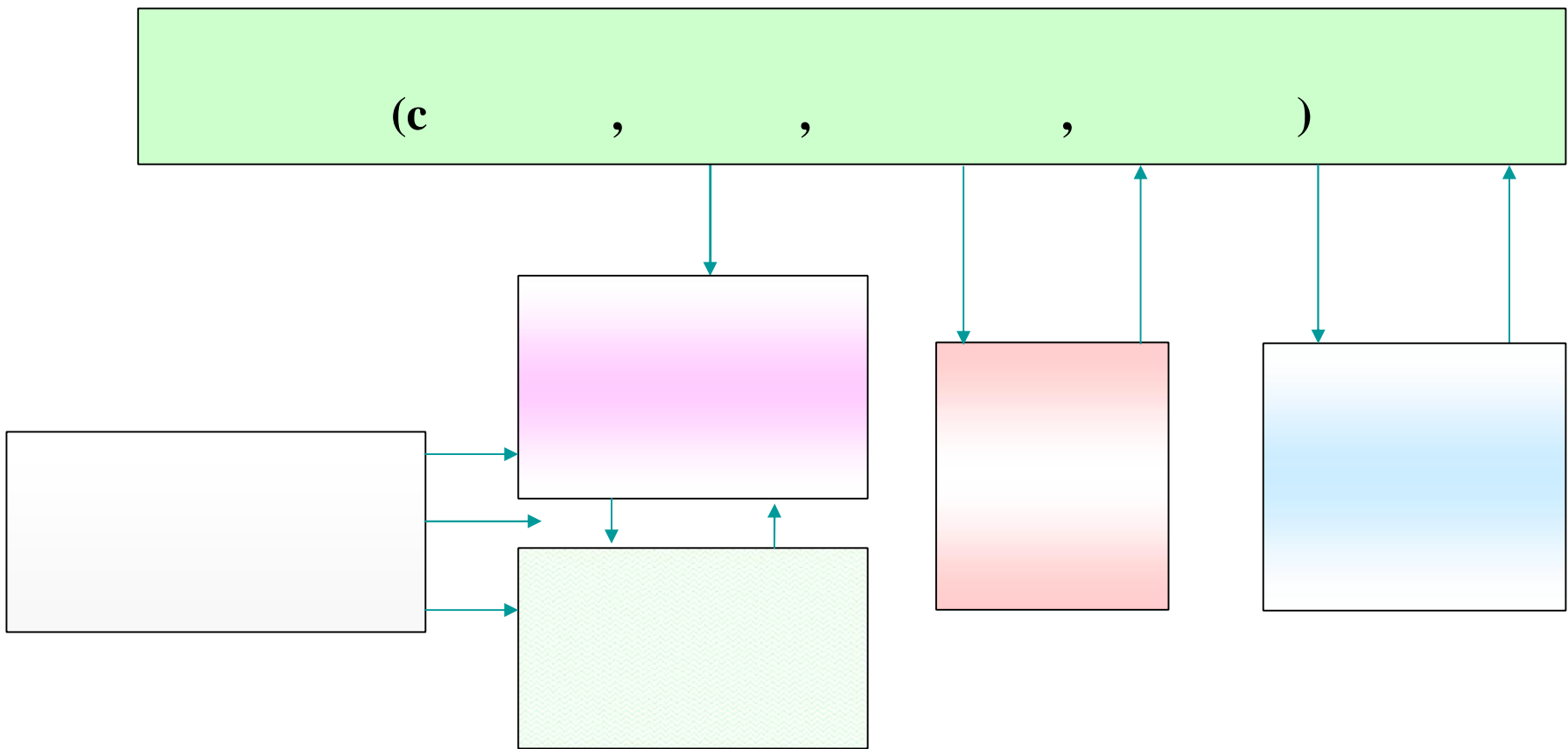

,

,

.

(

,

,

.)

-

,

.

,

,

,

-

()

.

() [effectiveness] –

.

,

() [efficiency] –

(

–

,

–

().

),

–

.

–

,

(

),

.

(

,

).

() [economy]

(

).

’ , ,
, _____ ,
_____ ,
_____,
_____ (

5.11.2008 976)

, ,
, - ,
, ,
.

«

»: <http://civic.kmu.gov.ua>

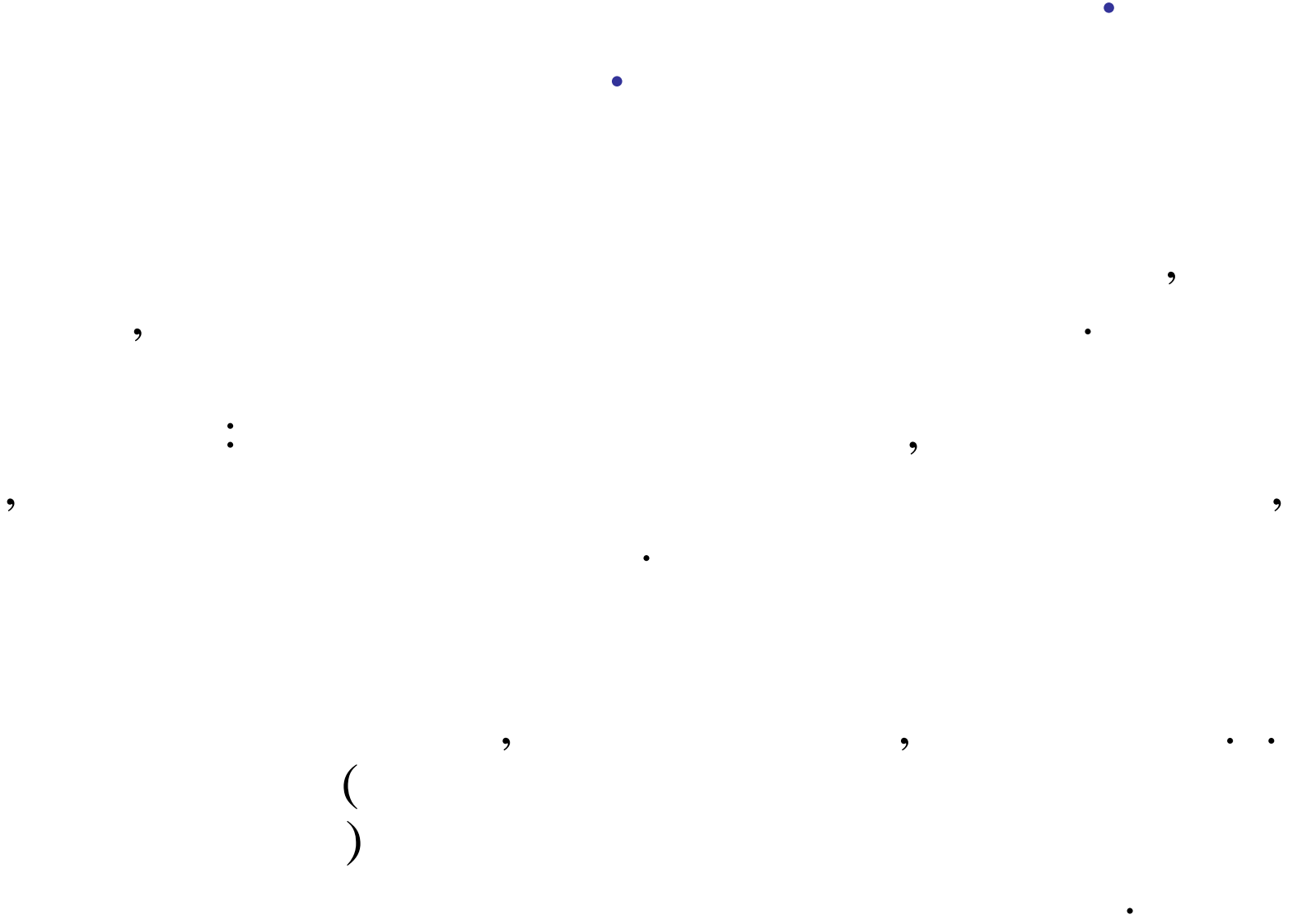

⋮

,

⋮

;

/

.

,

outputs,

:

,

outcomes.

•

—

•

—

/

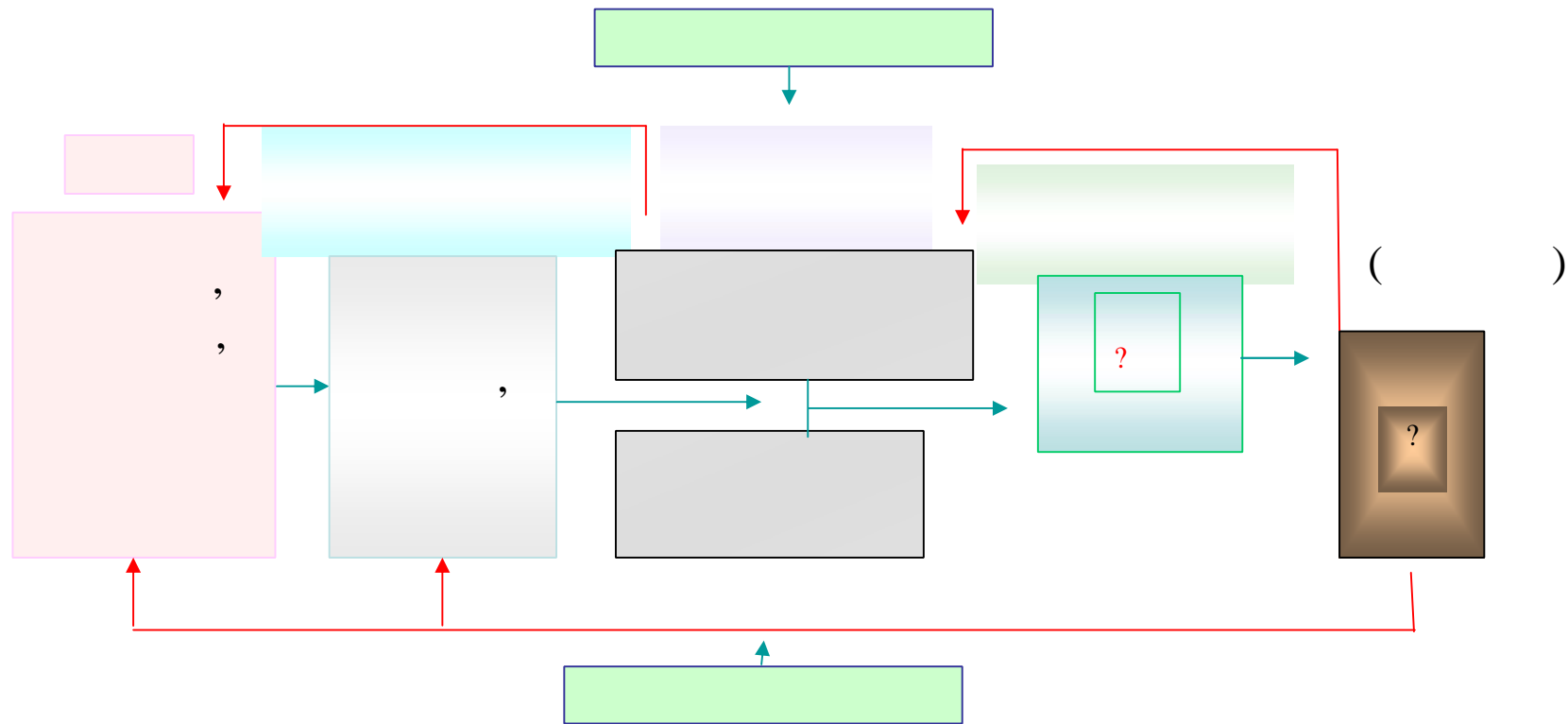



• : , , ,
 , , ;
 ,

(physical environment):

• - : , ,
 ;

• - : , ,
 , , ;

(n m environment):

• , , , ;
 ,

(litical environment):

• , , , , ,
 , , , , .

“ ” — ,
.

“ ” —
,

— (),
(,
) . , (, ,
) . ,



— , « » , ,
.
— , ,
.
— .
— (,) , ;
· (., « », — ,) .
, , — ·
, , — , ·
, , — , ·

(()) :

—

,

,

(

,

/

);

—

:

,

/

.

- . 15 2005 1276/2005
- . 8.07.2009 712
- . 6 2010 . 10
- . 15 2004 . 1378
- , ,
- . 11 2004 . 150
- . 5 2008 . 976
- . 21 2007 . N 1035-
- 2008
- 28.05.2008 . 764.



•

,

•

,
,

•

,

•

,

,

,

,

,

,

,

• ,

• ,

• - ,

-

• ,

,

• - ,

• - -

—

,

,

,

,

-
-
-
-
-

		. 1	. 2	. 3
1.	(Effectiveness)			
2.	(Efficiency)			
3.	(Equity)			
4.				
5.				

•

:

,

—

,

,

,

.

.

.

• ,

(, ,)

.(

,

).

:

,

,

(

),

(.

)

-

.

•

,

)

(

-

,

.(

,

,

,

).)

-

,

-

.

•

,

.

(

,

).

,

,

.

.

●

,

.

,

,

⋮

,

,

,

.

●

.

,

.

●

,

-

,

,

.

-

-

.

,

.

●

,

.

,

.

-

,

.

-
-
-
-
-
-
-

...

_____) 😊
'status-quo'

(...

-

,



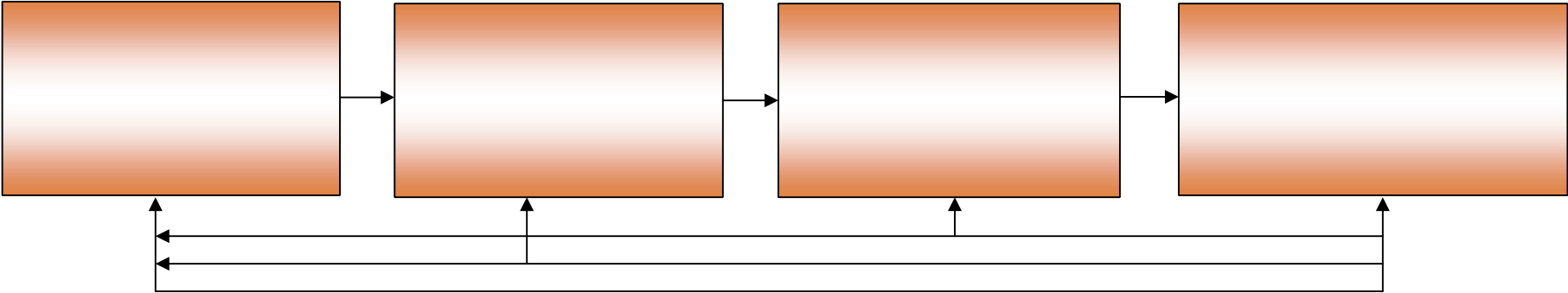

•

•

—

•
! ,
,
•

•

•

•

•
;

•
;

•
•

“

”

⋮

•

,

,

•

,

•

“

”

⋮

.

,

.

,

,

.

•

(

•

•

•

)

-

⋮

•

⋮

,

⋮

,

.

“

”

“

—

”

—

/

(.)

,

-

,

,

,

,

,

,

,

,

. . (

)

,

,

,

/

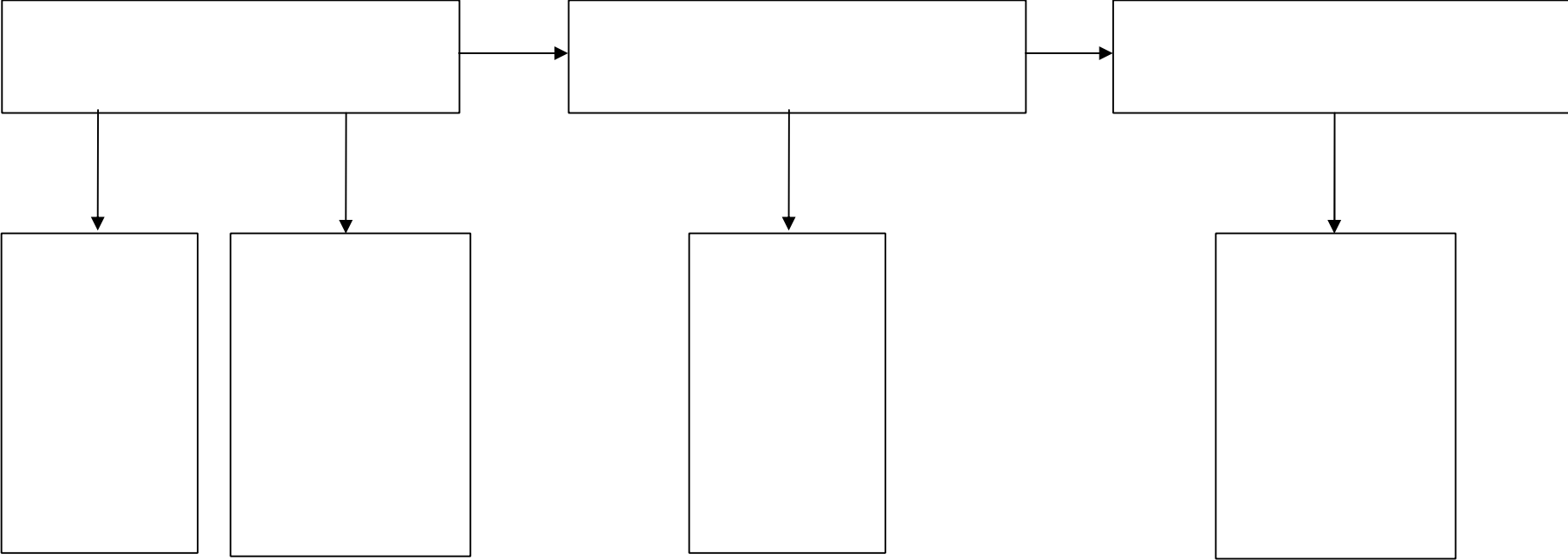

-

,

,

,

(

,

);

-

,

;

-

,

(

,

,

);

-

:

.

•
•

•
•
•
•
•
•
•
•
•
•
•
•

, (-)



,

,

,

:

—

,

,

?

—

,

,

?

—

,

,

.

•

•

•

•

;

•
•

-

;

-

(
)

.

;

) : (

•

•

• “ ”

• ,

• “ ”

• “ ”

⋮

•

•

•

•

,

,

—

“

”

-
-
-
-
-
-

•

—

,

,

⋮

•

—

,

?

?

?

?

,

?

,

?

,

?

,	;	;	;	;
;	;	;	;	;
;	;	;	;	;
;	;	;	;	;

•

—

,

,

.

,

,

.

;

•

—

,

.